

Varenummer: 201138015  
Beskrivelse: E+G Fingregreb  
GN 7336-53-M10-30-ST

## Mål

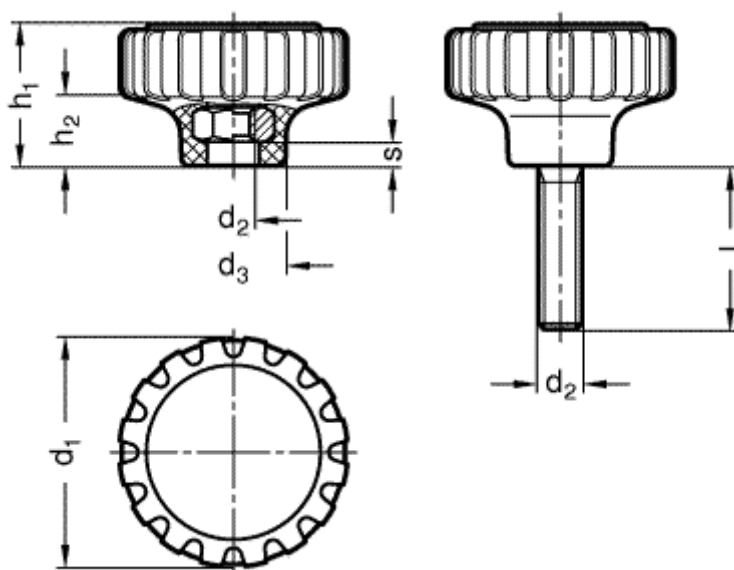

$d_1 = 53$   
 $d_2 = M 10$   
 $d_3 = 24$   
 $h_1 = 31$   
 $h_2 = 16$   
 $l = 30$   
 $s = 5$